

# Actuator

## LD20

LD20 is a compact actuator with high load capability which is designed for use in industrial, homecare and furniture. It's an ideal solution for the applications where installation space is limited, such as window opener or adjustable car driver seat.

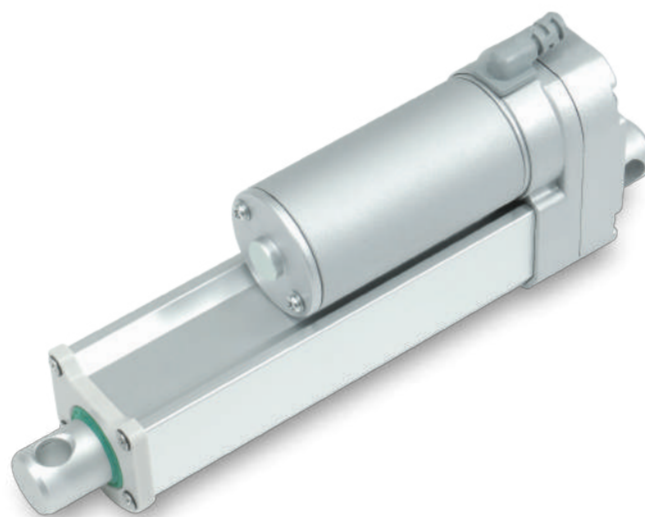

### Features and Options

**Main applications:** Industrial, Furniture, Home care, Medical

**Standard features:**

- Input voltage: 12 / 24 / 48V DC
- Max. load: 2500N (Push / Pull)
- Max. speed at no load: 27.5mm/sec (Typical value)
- Speed at full load: 4.6mm/sec (Typical value @2500N Loaded)
- Stroke: 100 / 150 / 200 / 250 / 300mm (Max. 300mm)
- Noise level:  $\leq 70$ dB
- IP level: IP65
- Color: Aluminum grey
- Preset limit switches
- Duty cycle: 25%, max.1 min continuous operation in 4 min.
- Operating ambient temperature:  $-25^{\circ}\text{C} \sim +65^{\circ}\text{C}$
- Certified: CE marking, EMC Directive 2014/30/EU, EN 60601 (for 24V DC motor without Hall effect sensor)

**Options:**

- Positioning signal feedback with Hall effect sensor x 1
- Positioning signal feedback with Hall effect sensor x 2
- Analog positioning feedback with Potentiometer (POT)

## Performance Data

### • 12V DC motor

Model No.	Gear ratio	Push/Pull Max. (N)	Self-locking force Max. (N)	* Typical speed (mm/s)		* Typical current (A)	
				No load	Full load	No load	Full load
LD20-12-10-G4-XXX-XXX0X	10:1	500	1500	26.8	18.6	1.3	4.4
LD20-12-20-G4-XXX-XXX0X	20:1	1000	4500	14.7	10.4	1.1	4.6
LD20-12-30-G4-XXX-XXX0X	30:1	1500	4500	9.9	6.8	1.0	4.3
LD20-12-40-G4-XXX-XXX0X	40:1	2000	4500	7.4	5.1	1.0	4.5
LD20-12-50-G4-XXX-XXX0X	50:1	2500	4500	6.2	4.4	0.9	4.1

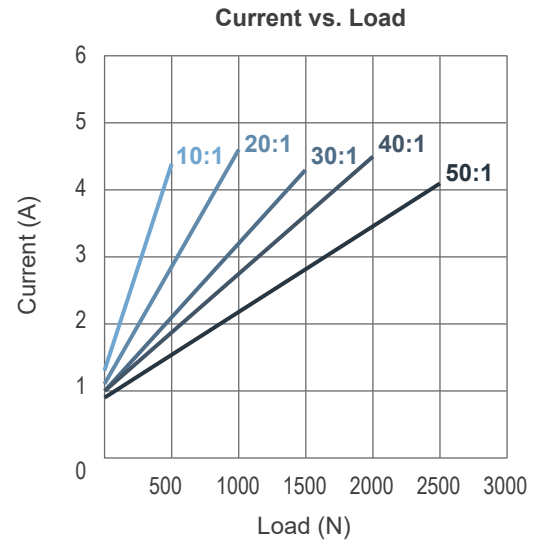
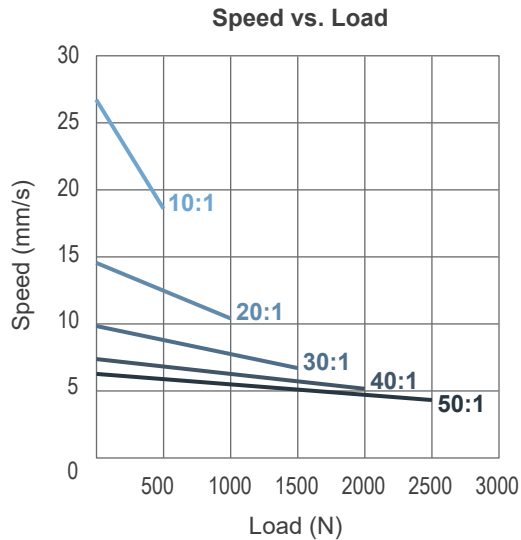

### • 24V DC motor

Model No.	Gear ratio	Push/Pull Max. (N)	Self-locking force Max. (N)	* Typical speed (mm/s)		* Typical current (A)	
				No load	Full load	No load	Full load
LD20-24-10-G4-XXX-XXX0X	10:1	500	1500	27.0	18.7	0.6	2.4
LD20-24-20-G4-XXX-XXX0X	20:1	1000	4500	15.1	10.7	0.5	2.3
LD20-24-30-G4-XXX-XXX0X	30:1	1500	4500	10.3	7.2	0.6	2.3
LD20-24-40-G4-XXX-XXX0X	40:1	2000	4500	7.6	5.7	0.6	2.3
LD20-24-50-G4-XXX-XXX0X	50:1	2500	4500	6.1	4.4	0.5	2.2

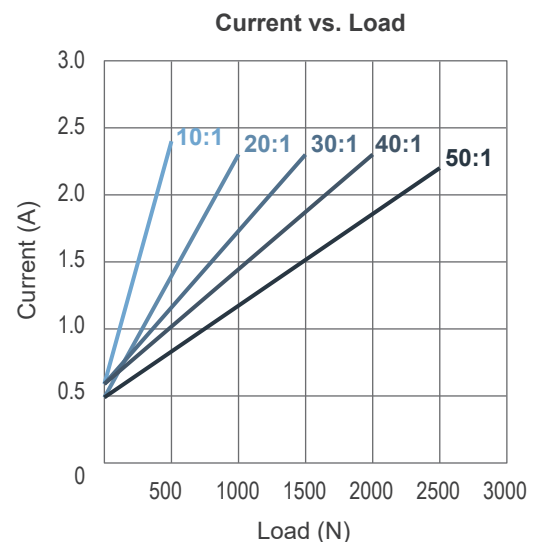
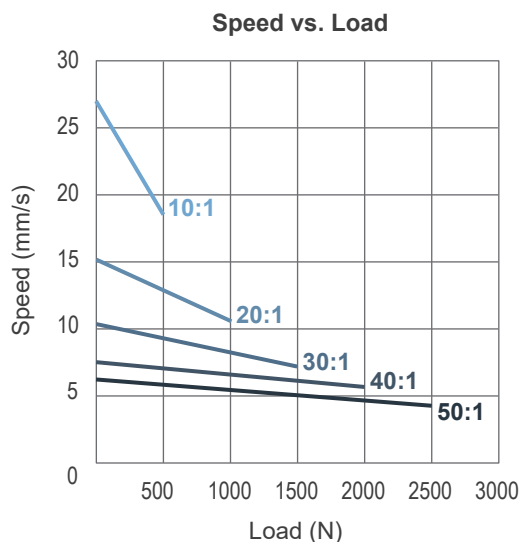

● 48V DC motor

Model No.	Gear ratio	Push/Pull Max. (N)	Self-locking force Max. (N)	* Typical speed (mm/s)		* Typical current (A)	
				No load	Full load	No load	Full load
LD20-48-10-G4-XXX-XXX0X	10:1	500	1500	27.5	19.5	0.4	1.4
LD20-48-20-G4-XXX-XXX0X	20:1	1000	4500	15.4	11.5	0.4	1.2
LD20-48-30-G4-XXX-XXX0X	30:1	1500	4500	10.5	7.4	0.3	1.3
LD20-48-40-G4-XXX-XXX0X	40:1	2000	4500	7.9	5.8	0.3	1.2
LD20-48-50-G4-XXX-XXX0X	50:1	2500	4500	6.4	4.6	0.3	1.2

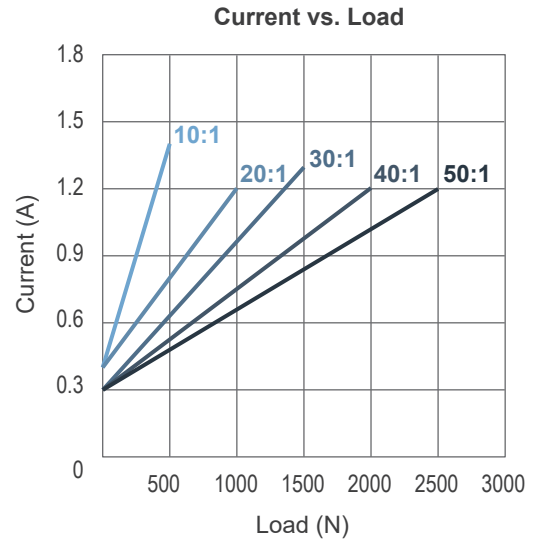
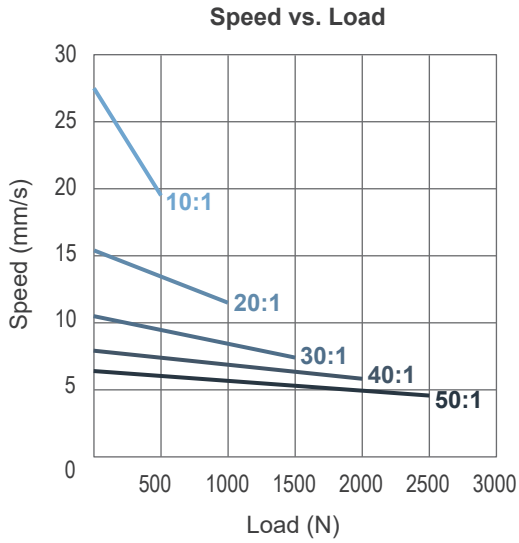

**Remarks:**

\* The typical speed or typical current means the average value neither upper limit nor lower limit. The performance curves are made with typical values.

## Dimensions

### Retracted length (A)

Option	Front connector code	Stroke (S)				
		100	150	200	250	300
Basic / Hall	1, 8	205	255	305	355	405
POT	1, 8	242	292	342	392	442

(tolerance:  $\pm 3\text{mm}$ )

### Drawing

- Basic / With Hall effect sensor positioning feedback

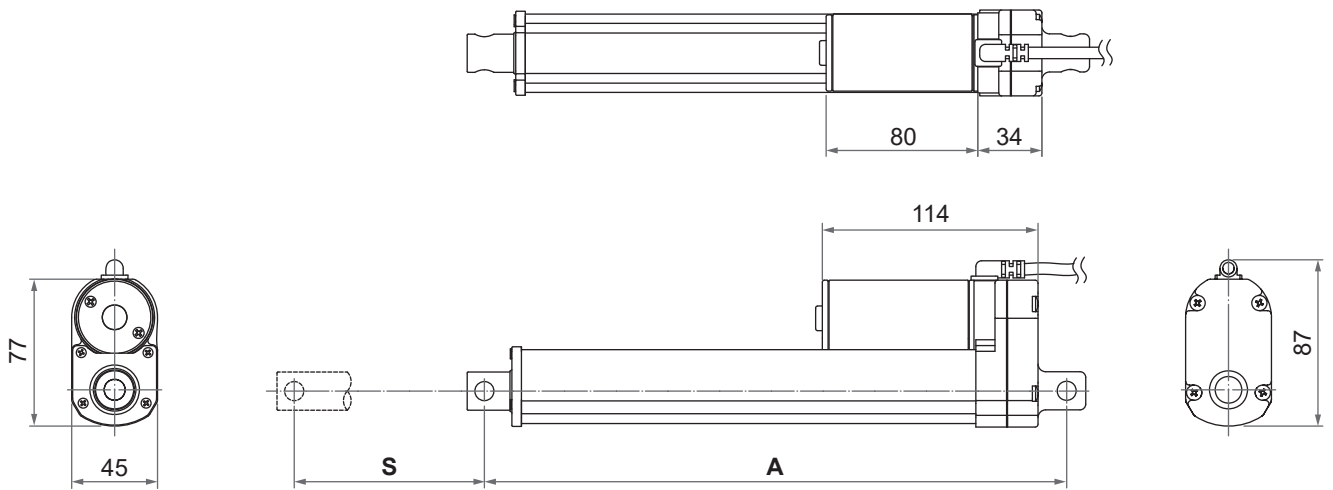

- With Potentiometer (POT)

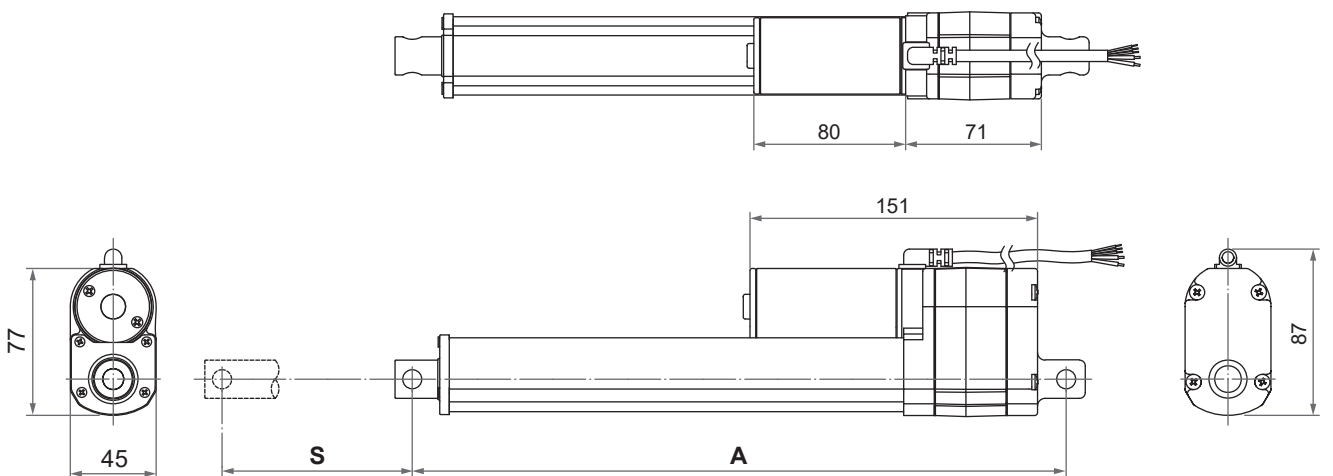

Unit: mm

- **Front connector**

- 1: Drilled hole,  $\varnothing 10\text{mm}$
- 8: Drilled hole,  $\varnothing 8\text{mm}$

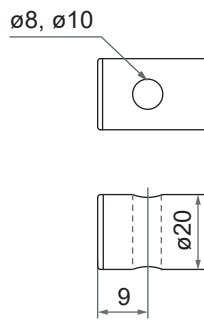

- **Rear connector**

- 1: Drilled hole,  $\varnothing 10\text{mm}$
- 8: Drilled hole,  $\varnothing 8\text{mm}$

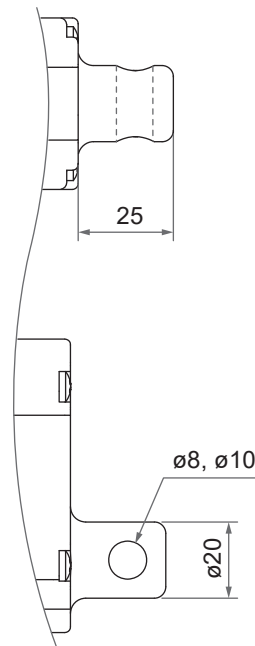

Unit: mm

## Cable with Flying Leads

- Basic, without positioning feedback.

	Wire color	Definition	Descriptions
Power wires	Red	DC power	Connect red wire to "Vdc +" & black wire to "Vdc -" of DC power to extend the actuator. Switch the polarity of DC input to retract it.
	Black		

- With Potentiometer (POT)

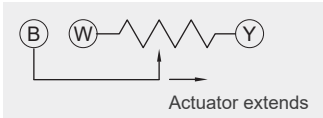
	Wire color	Definition	Descriptions												
Power wires	Red	DC power	Connect red wire to "Vdc +" & black wire to "Vdc -" of DC power to extend the actuator. Switch the polarity of DC input to retract it.												
	Black														
Signal wires	Yellow	Vin	Input voltage 70V max.												
	Blue	POT output	1. Potentiometer specification: <ul style="list-style-type: none"> <li>- 10K ohm, 10 turns.</li> <li>- Tolerance <math>\pm 5\%</math></li> </ul> 2. Output voltage: The voltage (resistance) between blue and white increases linearly from about 0 when the actuator extends, and decreases when it retracts. <div style="text-align: center;">  </div> 3. There are different resolutions according to the stroke length (as table below) <table border="1" style="margin-left: auto; margin-right: auto;"> <thead> <tr> <th>Stroke</th> <th>Resistance (tolerance: <math>\pm 0.3K\Omega</math>)</th> </tr> </thead> <tbody> <tr> <td>100mm</td> <td>0.3 ~ 8.8K</td> </tr> <tr> <td>150mm</td> <td>0.3 ~ 9.6K</td> </tr> <tr> <td>200mm</td> <td>0.3 ~ 8.9K</td> </tr> <tr> <td>250mm</td> <td>0.3 ~ 9.5K</td> </tr> <tr> <td>300mm</td> <td>0.3 ~ 9.5K</td> </tr> </tbody> </table>	Stroke	Resistance (tolerance: $\pm 0.3K\Omega$ )	100mm	0.3 ~ 8.8K	150mm	0.3 ~ 9.6K	200mm	0.3 ~ 8.9K	250mm	0.3 ~ 9.5K	300mm	0.3 ~ 9.5K
			Stroke	Resistance (tolerance: $\pm 0.3K\Omega$ )											
	100mm	0.3 ~ 8.8K													
150mm	0.3 ~ 9.6K														
200mm	0.3 ~ 8.9K														
250mm	0.3 ~ 9.5K														
300mm	0.3 ~ 9.5K														
White	GND														

• With single Hall effect sensor positioning feedback

	Wire color	Definition	Descriptions												
Power wires	Red	DC power	Connect red wire to "Vdc +" & black wire to "Vdc -" of DC power to extend the actuator. Switch the polarity of DC input to retract it.												
	Black														
Signal wires	Yellow	Vin	Voltage input range: 3.5 ~ 20V												
	Blue	Hall output	High= Input - 1.2V ( $\pm 0.6V$ ) Low= GND Hall signal data:   Hall effect sensor resolution: <table border="1" data-bbox="676 622 1327 904"> <thead> <tr> <th>Gear ratio</th> <th>Resolution (pulses/mm)</th> </tr> </thead> <tbody> <tr> <td>10:1</td> <td>2.56</td> </tr> <tr> <td>20:1</td> <td>4.75</td> </tr> <tr> <td>30:1</td> <td>7.16</td> </tr> <tr> <td>40:1</td> <td>9.66</td> </tr> <tr> <td>50:1</td> <td>11.82</td> </tr> </tbody> </table>	Gear ratio	Resolution (pulses/mm)	10:1	2.56	20:1	4.75	30:1	7.16	40:1	9.66	50:1	11.82
	Gear ratio	Resolution (pulses/mm)													
	10:1	2.56													
20:1	4.75														
30:1	7.16														
40:1	9.66														
50:1	11.82														
White	GND														

• With dual Hall effect sensor positioning feedback

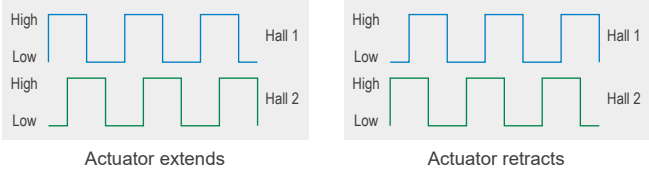
	Wire color	Definition	Descriptions												
Power wires	Red	DC power	Connect red wire to "Vdc +" & black wire to "Vdc -" of DC power to extend the actuator. Switch the polarity of DC input to retract it.												
	Black														
Signal wires	Yellow	Vin	Voltage input range: 3.5 ~ 20V												
	Blue	Hall 1 output	High= Input - 1.2V ( $\pm 0.6V$ ) Low= GND Hall signal data:   Hall effect sensor resolution: <table border="1" data-bbox="676 1704 1327 1986"> <thead> <tr> <th>Gear ratio</th> <th>Resolution (pulses/mm)</th> </tr> </thead> <tbody> <tr> <td>10:1</td> <td>2.56</td> </tr> <tr> <td>20:1</td> <td>4.75</td> </tr> <tr> <td>30:1</td> <td>7.16</td> </tr> <tr> <td>40:1</td> <td>9.66</td> </tr> <tr> <td>50:1</td> <td>11.82</td> </tr> </tbody> </table>	Gear ratio	Resolution (pulses/mm)	10:1	2.56	20:1	4.75	30:1	7.16	40:1	9.66	50:1	11.82
	Gear ratio	Resolution (pulses/mm)													
	10:1	2.56													
20:1	4.75														
30:1	7.16														
40:1	9.66														
50:1	11.82														
Green	Hall 2 output														
White	GND														

## Compatibility

Product	Model	LD20 spec
<b>Controller</b>	CI72	Standard
<b>Accessory</b>	MB22 mounting bracket (Fig. 1)	Standard, mounting hole $\varnothing$ 8mm or $\varnothing$ 10mm



Fig. 1

## Certifications

LD20 actuator is compliant with the following regulations, in terms of the essential conformity requirements of EMC Directive of 2014/30/EU.

Emission	Immunity
EN 61000-6-3:2007 + A1:2011	EN 61000-6-1:2007 IEC 61000-4-2:2008 IEC 61000-4-3:2006+A1:2007+A2:2010 IEC 61000-4-8:2009



## Ordering Key

LD20 - 24 - 20 - G4 - 100 - 1 1 D 0 3

<b>Input voltage</b>	<b>12:</b> 12V DC <b>24:</b> 24V DC <b>48:</b> 48V DC
<b>Gear ratio</b>	<b>10:</b> 10:1 <b>20:</b> 20:1 <b>30:</b> 30:1 <b>40:</b> 40:1 <b>50:</b> 50:1
<b>Motor and Spindle type</b>	<b>G4:</b> 4600rpm / Spindle pitch 4.23mm
<b>Stroke</b>	<b>100:</b> 100mm <b>150:</b> 150mm <b>200:</b> 200mm <b>250:</b> 250mm <b>300:</b> 300mm
<b>Front connector</b> <i>(Refer to Page 5)</i>	<b>1:</b> Drilled hole, $\varnothing$ 10mm <b>8:</b> Drilled hole, $\varnothing$ 8mm
<b>Rear connector</b> <i>(Refer to Page 5)</i>	<b>1:</b> Drilled hole, $\varnothing$ 10mm <b>8:</b> Drilled hole, $\varnothing$ 8mm
<b>Positioning feedback</b>	<b>0:</b> None <b>S:</b> Hall effect sensor x 1 <b>D:</b> Hall effect sensor x 2 <b>P:</b> Potentiometer (POT)
<b>Reserved</b>	<b>0</b>
<b>Cable length</b>	<b>0:</b> 300mm <b>3:</b> 900mm <b>5:</b> 1500mm <b>6:</b> 2000mm

RADIA S.R.L.  
 VIA MARCONI, 65/A - 10040 PIOBESI TORINESE (TO) - ITALY  
 TEL: + 39.011.9936019  
 E-MAIL: [INFOWEB@RADIAMOTION.COM](mailto:INFOWEB@RADIAMOTION.COM)  
 WEB: [WWW.RADIAMOTION.COM](http://WWW.RADIAMOTION.COM)